



UNIVERSITY OF CAMBRIDGE INTERNATIONAL EXAMINATIONS
General Certificate of Education Ordinary Level

CHEMISTRY

5070/12

Paper 1 Multiple Choice

October/November 2012

1 hour

Additional Materials: Multiple Choice Answer Sheet
 Soft clean eraser
 Soft pencil (type B or HB recommended)



READ THESE INSTRUCTIONS FIRST

Write in soft pencil.

Do not use staples, paper clips, highlighters, glue or correction fluid.

Write your name, Centre number and candidate number on the Answer Sheet in the spaces provided unless this has been done for you.

There are **forty** questions on this paper. Answer **all** questions. For each question there are four possible answers **A, B, C** and **D**.

Choose the **one** you consider correct and record your choice in **soft pencil** on the separate Answer Sheet.

Read the instructions on the Answer Sheet very carefully.

Each correct answer will score one mark. A mark will not be deducted for a wrong answer.

Any rough working should be done in this booklet.

A copy of the Periodic Table is printed on page 16.

This document consists of **13** printed pages and **3** blank pages.



1 Which is a property of hydrogen gas?

- A It burns in air.
- B It has an unpleasant smell.
- C It relights a glowing splint.
- D It turns moist litmus paper red.

2 Four identical balloons are filled with different gases all at the same temperature and pressure.

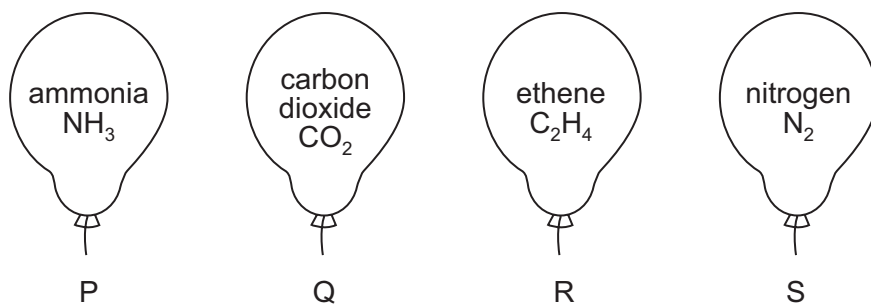

The gases gradually diffuse out of the balloons.

Which pair of balloons will deflate at the same rate?

- A P and Q
- B Q and R
- C R and S
- D S and P

3 Hydrogen chloride is very soluble in water, whereas chlorine is only slightly soluble in water.

Both gases can be dried using concentrated sulfuric acid.

Which diagram represents the correct method of obtaining pure dry chlorine from damp chlorine containing a small amount of hydrogen chloride?

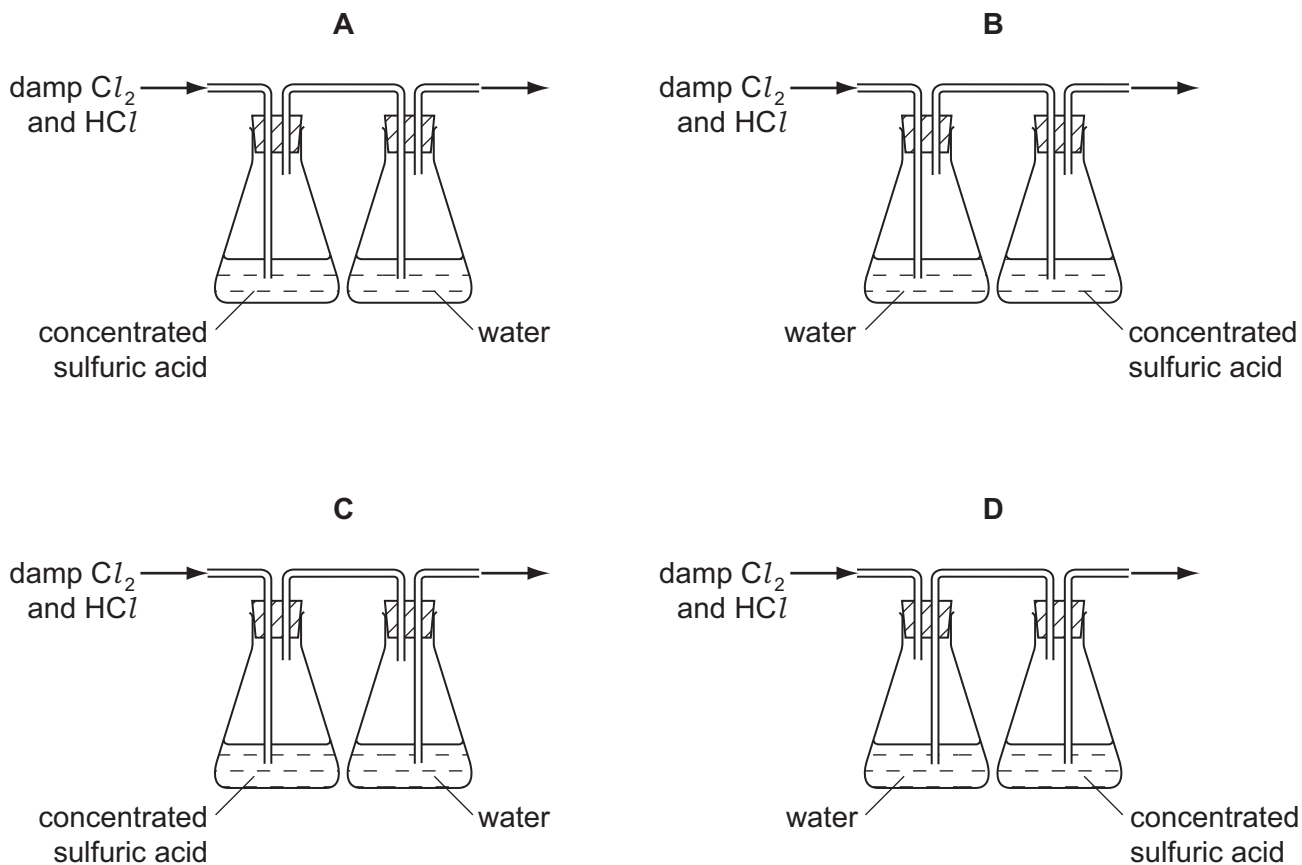

4 Two particles have the compositions shown.

	electrons	neutrons	protons
X	4	6	5
Y	6	4	5

Which statement about X and Y is correct?

- A They are both positively charged.
- B They are particles of the same element.
- C They have the same mass number.
- D They have the same number of nucleons.

5 Which of the following is **not** a mixture?

- A ethanol
- B petrol
- C steel
- D tap water

6 When concentrated aqueous sodium chloride is electrolysed using carbon electrodes, which row correctly states the products at the electrodes and the solution remaining?

	cathode (-)	anode (+)	solution remaining
A	chlorine	hydrogen	hydrochloric acid
B	hydrogen	chlorine	sodium hydroxide
C	hydrogen	oxygen	sodium chloride
D	sodium	chlorine	water

7 Carbon and silicon are both in Group IV of the Periodic Table, but at room temperature CO_2 is a gas whereas SiO_2 is a solid.

Which statement explains this?

- A Covalent bonding is weaker in CO_2 .
- B Covalent bonds in CO_2 are double bonds and in SiO_2 the covalent bonds are single bonds.
- C CO_2 is a covalent compound and SiO_2 is ionic.
- D CO_2 is a simple covalent molecule and SiO_2 is a macromolecule.

8 An ionic compound has the formula X_3Y_2 .

To which groups of the Periodic Table do X and Y belong?

	group for X	group for Y
A	II	III
B	III	II
C	II	V
D	V	II

9 When two solutions are mixed, a precipitate of a magnesium compound is formed.

Which salt would be formed from solution as a precipitate?

- A MgCO_3
- B MgCl_2
- C $\text{Mg}(\text{NO}_3)_2$
- D MgSO_4

10 Which substance has metallic bonding?

	conducts electricity		state of substance formed on reaction with oxygen
	when solid	when liquid	
A	✓	✓	solid
B	✓	✓	gas
C	x	✓	no reaction
D	x	x	solid

11 In separate experiments sulfur dioxide, a reducing agent, was passed through acidified solutions of potassium dichromate(VI) and potassium manganate(VII).

Which pair describes the colour changes observed in the experiments?

	colour change of potassium dichromate(VI)	colour change of potassium manganate(VII)
A	orange to green	pink to colourless
B	colourless to green	green to pink
C	colourless to orange	pink to green
D	orange to green	colourless to pink

12 In the experiment shown in the diagram, the bulb lights and two colourless gases are formed, one at each electrode.

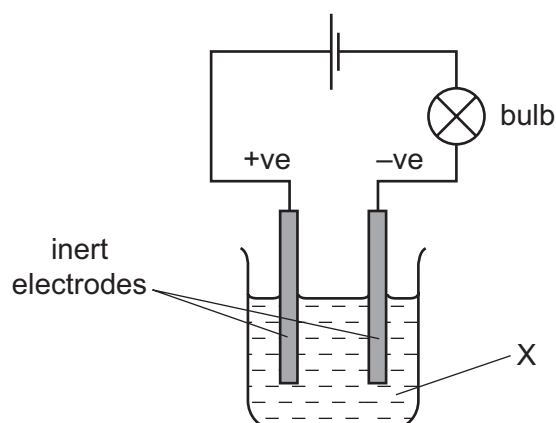

What is X?

- A** concentrated aqueous sodium chloride
- B** dilute sulfuric acid
- C** methanol
- D** molten sodium chloride

- 13 0.5 mol/dm³ hydrochloric acid is added gradually to a flask containing 20 cm³ of 2 mol/dm³ sodium hydroxide solution.

What is the total volume, in cm³, of the mixture in the flask when the solution is just neutral?

- A 30 B 40 C 60 D 100

- 14 Two of the reactions used in the manufacture of nitric acid, HNO₃, are shown.

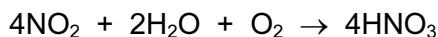
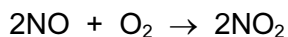

What is the maximum number of moles of nitric acid which could be formed from one mole of nitrogen monoxide, NO?

- A 0.5 B 1.0 C 2.0 D 4.0

- 15 Sulfur trioxide is produced by the following reaction.



Which change in conditions would produce a greater yield of SO₃ at equilibrium?

- A adding a catalyst
 B increasing the pressure
 C increasing the temperature
 D removing some SO₂ and O₂

- 16 Solution X has a pH value of 12. It is added to aqueous ammonium chloride and the mixture is warmed.

Which information is correct?

	solution X is	when the mixture is warmed
A	acidic	ammonia gas is given off
B	acidic	no gas is given off
C	alkaline	ammonia gas is given off
D	alkaline	no gas is given off

- 17 Which compound contains only eight covalent bonds?

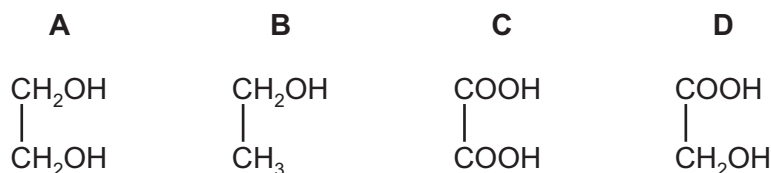

18 Why does an increase in pressure increase the rate of reaction between the gases nitrogen and hydrogen in the manufacture of ammonia?

- A The activation energy is lowered.
- B The molecules collide more frequently.
- C The molecules have more energy.
- D The reaction is more exothermic.

19 The diagram shows the steps by which carbon dioxide can be converted into organic products and finally returned to the atmosphere.

Which step is an example of combustion?

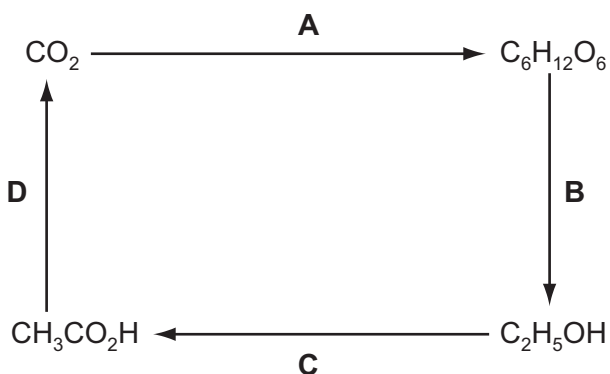

20 The diagram shows some reactions of copper compounds.

Which change is made by adding an acid?

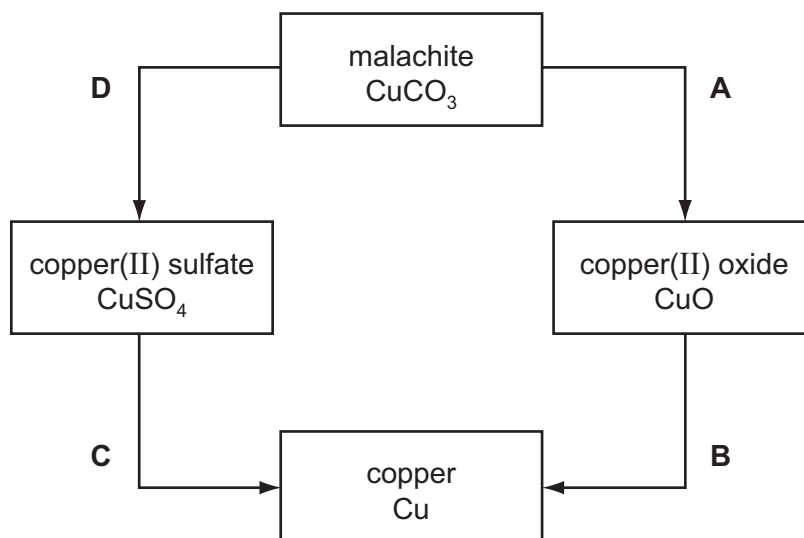

21 What is the effect of a catalyst on the activation energy and on the enthalpy change, ΔH , of a reaction?

	activation energy	ΔH
A	decreases	decreases
B	decreases	unchanged
C	increases	decreases
D	increases	unchanged

22 Which substance in the table could be an amphoteric oxide?

	reaction with dilute hydrochloric acid	reaction with water	reaction with sodium hydroxide
A	dissolves	insoluble	dissolves
B	dissolves	insoluble	insoluble
C	insoluble	dissolves	insoluble
D	insoluble	insoluble	dissolves

23 Which element in the table is an alkali metal?

	melting point °C	density g/cm ³
A	-39	13.60
B	-7	3.10
C	98	0.97
D	1083	8.92

24 Which compound is present in sand in the largest proportion?

- A** Al_2O_3 **B** $CaSO_4$ **C** $NaCl$ **D** SiO_2

25 Atoms of elements X and Y have the electron configurations 2,5 and 2,8,5 respectively.

Which deduction about these elements can be made from this information?

- A** The atoms are isomers.
B The atoms are isotopes.
C The elements are in the same group of the Periodic Table.
D The elements are in the same period of the Periodic Table.

26 What is the function of silica, SiO_2 , in the equation shown below?

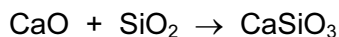

- A a basic oxide
 B a reducing agent
 C an acidic oxide
 D an oxidising agent
- 27 Which gas **can** be removed from the exhaust gases of a petrol-powered car by its catalytic converter?
- A carbon monoxide
 B carbon dioxide
 C nitrogen
 D steam
- 28 Metal **M** will displace copper from aqueous copper(II) sulfate solution, but will not displace iron from aqueous iron(II) sulfate solution. **M** is extracted from its oxide by heating the oxide with carbon.

What is the order of reactivity of these four metals?

	least reactive	—————→	most reactive	
A	sodium	metal M	iron	copper
B	sodium	iron	metal M	copper
C	copper	iron	metal M	sodium
D	copper	metal M	iron	sodium

29 Which substance in the table is the element iodine?

	state at room temperature	electrical conductivity when molten
A	liquid	good
B	liquid	none
C	solid	good
D	solid	none

30 Iron pipes corrode rapidly when exposed to sea water.

Which metal, when attached to the iron, would **not** offer protection against corrosion?

- A aluminium
- B copper
- C magnesium
- D zinc

31 Which method is used in industry to extract aluminium from bauxite?

- A electrolysis
- B heating alone
- C heating with carbon
- D heating with magnesium

32 Which row shows both the correct source and the correct effect of the named pollutant?

	pollutant	source	effect
A	carbon monoxide	incomplete combustion of carbon-containing materials	global warming
B	oxides of nitrogen	decaying vegetable matter	global warming
C	ozone	photochemical reactions	acid rain
D	sulfur dioxide	volcanoes	acid rain

33 A sample of soil has a nitrogenous fertiliser in the form of an ammonium salt added to it. The ammonium salt dissolves in the water in the soil.

When tested a week later, the water in the soil contained 15.3% of dissolved nitrogen and had a pH of 4.6.

Calcium hydroxide was added to the soil and then the water in the soil was tested the next day, both for nitrogen content and pH.

What would be the most likely result of the final test?

	% of nitrogen	pH
A	11.4	3.8
B	12.7	6.9
C	15.3	4.6
D	19.8	4.2

34 The diagram shows a flow chart for the manufacture of fertiliser.

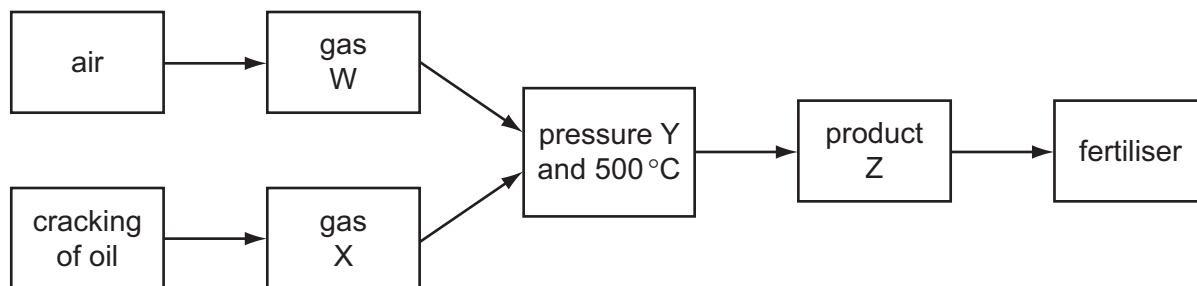

In the flow chart, what are W, X, Y and Z?

	W	X	Y	Z
A	H ₂	N ₂	high	NH ₃
B	O ₂	SO ₂	high	SO ₃
C	O ₂	SO ₂	low	SO ₃
D	N ₂	H ₂	high	NH ₃

35 A factory manufactures poly(ethene).

Which raw material will the factory need?

- A** bitumen
- B** methane
- C** methanol
- D** naphtha

36 Starch is a carbohydrate and is broken down to simple sugars by saliva in the mouth.

What is the name for this reaction?

- A** condensation
- B** fermentation
- C** hydrolysis
- D** polymerisation

37 If 1 mole of each alkane is completely burned in oxygen, which will provide 7 moles of products?

- A** CH₄
- B** C₂H₆
- C** C₃H₈
- D** C₄H₁₀

38 An alcohol contains 60% carbon by mass.

What is its formula?

- A CH_3OH B $\text{C}_2\text{H}_5\text{OH}$ C $\text{C}_3\text{H}_7\text{OH}$ D $\text{C}_4\text{H}_9\text{OH}$

39 The alcohol $\text{C}_4\text{H}_9\text{OH}$ on oxidation with acidified potassium dichromate(VI) will give a carboxylic acid X.

Which acid is X?

- A $\text{C}_4\text{H}_9\text{COOH}$ B $\text{C}_3\text{H}_7\text{COOH}$ C $\text{C}_2\text{H}_5\text{COOH}$ D CH_3COOH

40 Which compound has a pH of less than 7?

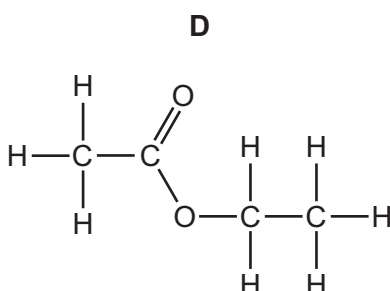
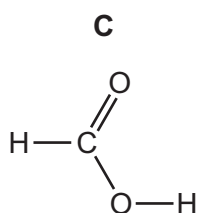
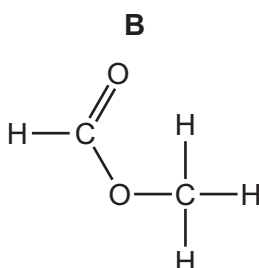
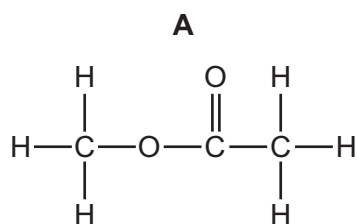

DATA SHEET
The Periodic Table of the Elements

		Group													
I	II	III	IV	V	VI	VII	0								
7 Li Lithium 3	9 Be Beryllium 4	1 H Hydrogen 1					4 He Helium 2						20 Ne Neon 10		
23 Na Sodium 11	24 Mg Magnesium 12	27 Al Aluminium 13	28 Si Silicon 14	31 P Phosphorus 15	32 S Sulfur 16	35.5 Cl Chlorine 17	40 Ar Argon 18						84 Kr Krypton 36		
39 K Potassium 19	40 Ca Calcium 20	56 Fe Iron 26	55 Mn Manganese 25	59 Co Cobalt 27	59 Ni Nickel 28	64 Cu Copper 29	70 Ga Gallium 31	73 Ge Germanium 32	75 As Arsenic 33	79 Se Selenium 34	80 Br Bromine 35	131 Xe Xenon 54			
85 Rb Rubidium 37	88 Sr Strontium 38	101 Ru Ruthenium 44	106 Pd Palladium 46	103 Rh Rhodium 45	106 Pt Platinum 78	108 Ag Silver 47	115 In Indium 49	119 Sn Tin 50	122 Sb Antimony 51	128 Te Tellurium 52	127 I Iodine 53	209 Po Polonium 84			
133 Cs Caesium 55	137 Ba Barium 56	141 Pr Praseodymium 59	144 Nd Neodymium 60	150 Sm Samarium 62	152 Eu Europium 63	157 Gd Gadolinium 64	162 Dy Dysprosium 66	165 Ho Holmium 67	167 Er Erbium 68	169 Tm Thulium 69	173 Yb Ytterbium 70	175 Lu Lutetium 71			
226 Ra Radium 88	227 Ac Actinium 89	140 Ce Cerium 58	141 Pr Praseodymium 59	150 Sm Samarium 62	152 Eu Europium 63	157 Gd Gadolinium 64	162 Dy Dysprosium 66	165 Ho Holmium 67	167 Er Erbium 68	169 Tm Thulium 69	173 Yb Ytterbium 70	175 Lu Lutetium 71			
87 Fr Francium		232 Th Thorium 90	238 U Uranium 92	91 Pa Protactinium 91	93 Np Neptunium 93	94 Pu Plutonium 94	95 Am Americium 95	96 Cm Curium 96	97 Bk Berkelium 97	98 Cf Californium 98	99 Es Einsteinium 99	100 Fm Fermium 100	101 Md Mendelevium 101	102 No Nobelium 102	103 Lr Lawrencium 103

* 58-71 Lanthanoid series
† 90-103 Actinoid series

a	X	b
Key		b

a = relative atomic mass
 X = atomic symbol
 b = proton (atomic) number

The volume of one mole of any gas is 24 dm³ at room temperature and pressure (r.t.p.).

Permission to reproduce items where third-party owned material protected by copyright is included has been sought and cleared where possible. Every reasonable effort has been made by the publisher (UCLES) to trace copyright holders, but if any items requiring clearance have unwittingly been included, the publisher will be pleased to make amends at the earliest possible opportunity.

University of Cambridge International Examinations is part of the Cambridge Assessment Group. Cambridge Assessment is the brand name of University of Cambridge Local Examinations Syndicate (UCLES), which is itself a department of the University of Cambridge.