



UNIVERSITY OF CAMBRIDGE INTERNATIONAL EXAMINATIONS  
General Certificate of Education  
Advanced Subsidiary Level and Advanced Level

---

**PHYSICS**

**9702/11**

Paper 1 Multiple Choice

**October/November 2012**

**1 hour**

Additional Materials:      Multiple Choice Answer Sheet  
                                         Soft clean eraser  
                                         Soft pencil (type B or HB is recommended)



---

**READ THESE INSTRUCTIONS FIRST**

Write in soft pencil.

Do not use staples, paper clips, highlighters, glue or correction fluid.

Write your name, Centre number and candidate number on the Answer Sheet in the spaces provided unless this has been done for you.

There are **forty** questions on this paper. Answer **all** questions. For each question there are four possible answers **A, B, C** and **D**.

Choose the **one** you consider correct and record your choice in **soft pencil** on the separate Answer Sheet.

**Read the instructions on the Answer Sheet very carefully.**

Each correct answer will score one mark. A mark will not be deducted for a wrong answer.  
Any working should be done in this booklet.

---

This document consists of **26** printed pages and **2** blank pages.



**Data**

|                               |                                                                                                                          |
|-------------------------------|--------------------------------------------------------------------------------------------------------------------------|
| speed of light in free space, | $c = 3.00 \times 10^8 \text{ m s}^{-1}$                                                                                  |
| permeability of free space,   | $\mu_0 = 4\pi \times 10^{-7} \text{ H m}^{-1}$                                                                           |
| permittivity of free space,   | $\epsilon_0 = 8.85 \times 10^{-12} \text{ F m}^{-1}$<br>$(\frac{1}{4\pi\epsilon_0} = 8.99 \times 10^9 \text{ m F}^{-1})$ |
| elementary charge,            | $e = 1.60 \times 10^{-19} \text{ C}$                                                                                     |
| the Planck constant,          | $h = 6.63 \times 10^{-34} \text{ J s}$                                                                                   |
| unified atomic mass constant, | $u = 1.66 \times 10^{-27} \text{ kg}$                                                                                    |
| rest mass of electron,        | $m_e = 9.11 \times 10^{-31} \text{ kg}$                                                                                  |
| rest mass of proton,          | $m_p = 1.67 \times 10^{-27} \text{ kg}$                                                                                  |
| molar gas constant,           | $R = 8.31 \text{ J K}^{-1} \text{ mol}^{-1}$                                                                             |
| the Avogadro constant,        | $N_A = 6.02 \times 10^{23} \text{ mol}^{-1}$                                                                             |
| the Boltzmann constant,       | $k = 1.38 \times 10^{-23} \text{ J K}^{-1}$                                                                              |
| gravitational constant,       | $G = 6.67 \times 10^{-11} \text{ N m}^2 \text{ kg}^{-2}$                                                                 |
| acceleration of free fall,    | $g = 9.81 \text{ m s}^{-2}$                                                                                              |

**Formulae**

|                                 |                                                                |
|---------------------------------|----------------------------------------------------------------|
| uniformly accelerated motion,   | $s = ut + \frac{1}{2}at^2$<br>$v^2 = u^2 + 2as$                |
| work done on/by a gas,          | $W = p\Delta V$                                                |
| gravitational potential,        | $\phi = -\frac{Gm}{r}$                                         |
| hydrostatic pressure,           | $p = \rho gh$                                                  |
| pressure of an ideal gas,       | $p = \frac{1}{3}\frac{Nm}{V}\langle c^2 \rangle$               |
| simple harmonic motion,         | $a = -\omega^2 x$                                              |
| velocity of particle in s.h.m., | $v = v_0 \cos \omega t$<br>$v = \pm \omega \sqrt{x_0^2 - x^2}$ |
| electric potential,             | $V = \frac{Q}{4\pi\epsilon_0 r}$                               |
| capacitors in series,           | $1/C = 1/C_1 + 1/C_2 + \dots$                                  |
| capacitors in parallel,         | $C = C_1 + C_2 + \dots$                                        |
| energy of charged capacitor,    | $W = \frac{1}{2}QV$                                            |
| resistors in series,            | $R = R_1 + R_2 + \dots$                                        |
| resistors in parallel,          | $1/R = 1/R_1 + 1/R_2 + \dots$                                  |
| alternating current/voltage,    | $x = x_0 \sin \omega t$                                        |
| radioactive decay,              | $x = x_0 \exp(-\lambda t)$                                     |
| decay constant,                 | $\lambda = \frac{0.693}{t_{\frac{1}{2}}}$                      |

1 What is the unit of weight in terms of SI base unit(s)?

- A  $\text{kgms}^{-1}$       B  $\text{kgms}^{-2}$       C N      D  $\text{Jm}^{-1}$

2 Vectors P and Q are drawn to scale.



Which diagram represents the vector  $(P - Q)$ ?

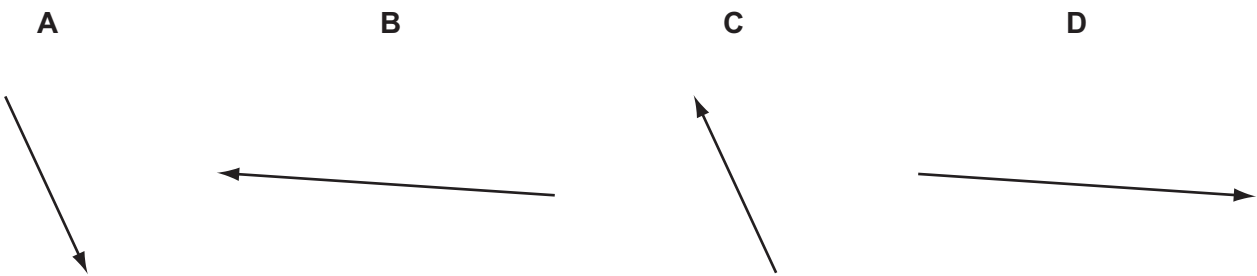

3 What is the approximate temperature of a red-hot ring on an electric cooker?

- A  $100^\circ\text{C}$       B  $200^\circ\text{C}$       C  $400^\circ\text{C}$       D  $800^\circ\text{C}$

**Space for working**

- 4 Which list contains only scalar quantities?
- A area, length, displacement
  - B kinetic energy, speed, power
  - C potential energy, momentum, time
  - D velocity, distance, temperature
- 5 The density of the material of a coil of thin wire is to be found.  
Which set of instruments could be used to do this most accurately?
- A metre rule, protractor, spring balance
  - B micrometer, metre rule, top-pan balance
  - C stopwatch, newton-meter, vernier calipers
  - D tape measure, vernier calipers, lever balance

**Space for working**

- 6 A quantity  $X$  varies with temperature  $\theta$  as shown.

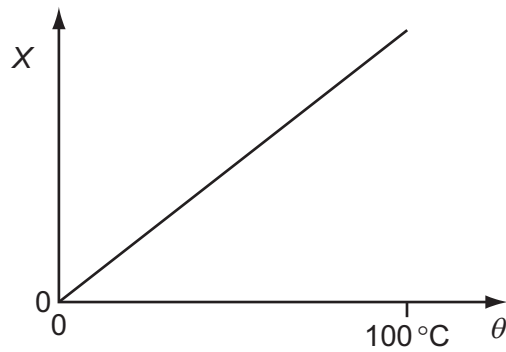

$\theta$  is determined from the corresponding values of  $X$  by using this graph.  
 $X$  is measured with a percentage uncertainty of  $\pm 1\%$  of its value at all temperatures.

Which statement about the uncertainty in  $\theta$  is correct?

- A The percentage uncertainty in  $\theta$  is least near  $0^\circ\text{C}$ .
  - B The percentage uncertainty in  $\theta$  is least near  $100^\circ\text{C}$ .
  - C The actual uncertainty in  $\theta$  is least near  $0^\circ\text{C}$ .
  - D The actual uncertainty in  $\theta$  is least near  $100^\circ\text{C}$ .
- 7 The measurement of a physical quantity may be subject to random errors and to systematic errors.

Which statement is correct?

- A Random errors can be reduced by taking the average of several measurements.
- B Random errors are always caused by the person taking the measurement.
- C A systematic error cannot be reduced by adjusting the apparatus.
- D A systematic error results in a different reading each time the measurement is taken.

**Space for working**

- 8 The velocity of an electric car changes as shown.

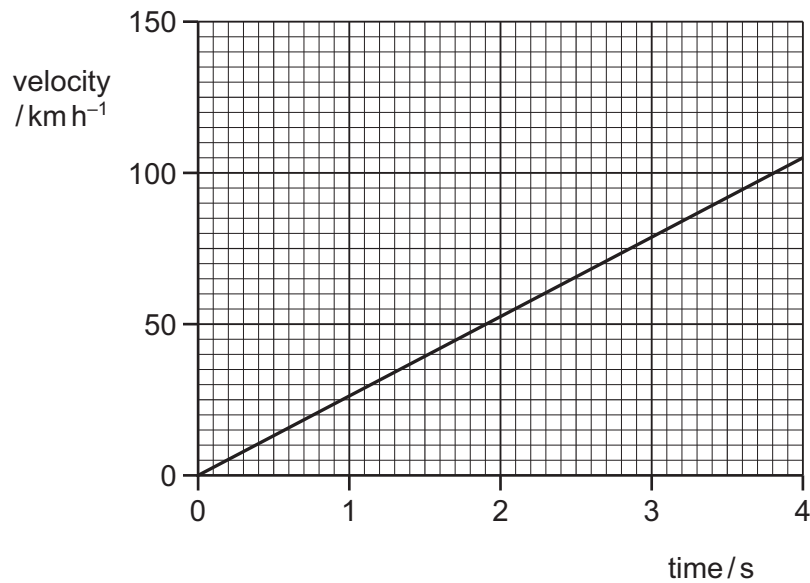

What is the acceleration of the car?

- A**  $190 \text{ ms}^{-2}$       **B**  $53 \text{ ms}^{-2}$       **C**  $26 \text{ ms}^{-2}$       **D**  $7.3 \text{ ms}^{-2}$
- 9 A ball is thrown vertically in air.
- Neglecting air resistance, which property of the ball can **never** be zero at any time during the flight?
- A** acceleration  
**B** kinetic energy  
**C** speed  
**D** velocity

**Space for working**

10 A golf ball is hit with the same force and direction on the Earth and on the Moon.

Which diagram best represents the shapes of the paths taken by the golf ball?

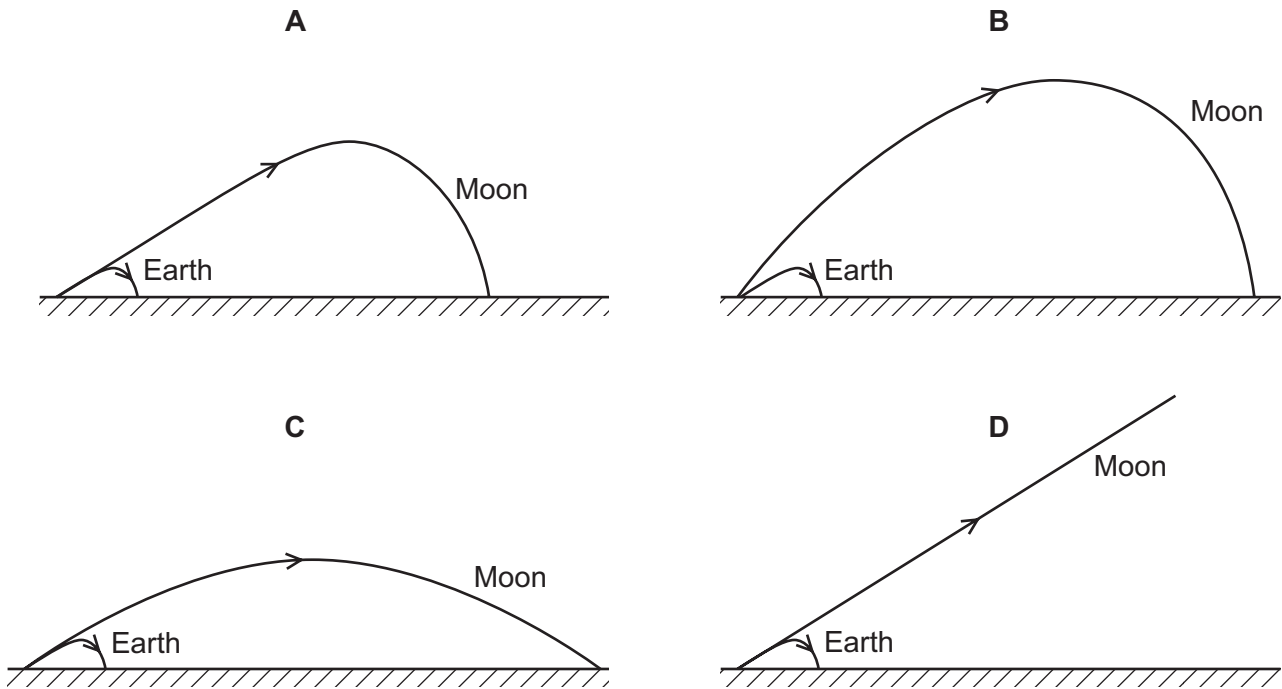

Space for working



11 An object travelling with velocity  $v$  strikes a wall and rebounds as shown.

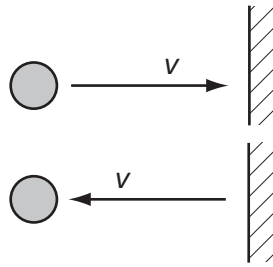

Which property of the object is **not** conserved?

- A kinetic energy
- B mass
- C momentum
- D speed

**Space for working**

- 12 A particle X has speed  $v$  and collides with a stationary identical particle Y. The collision is perfectly elastic.

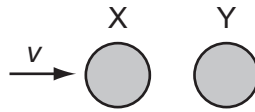

What are the speed and direction of motion of each of the two particles after the collision?

|          | X                          | Y                          |
|----------|----------------------------|----------------------------|
| <b>A</b> | stationary                 | $v$ to the right           |
| <b>B</b> | $\frac{v}{2}$ to the right | $\frac{v}{2}$ to the right |
| <b>C</b> | $\frac{v}{2}$ to the left  | $\frac{v}{2}$ to the right |
| <b>D</b> | $v$ to the left            | stationary                 |

**Space for working**

- 13 A mass of 2.0 kg rests on a frictionless surface. It is attached to a 1.0 kg mass by a light, thin string which passes over a frictionless pulley. The 1.0 kg mass is released and it accelerates downwards.

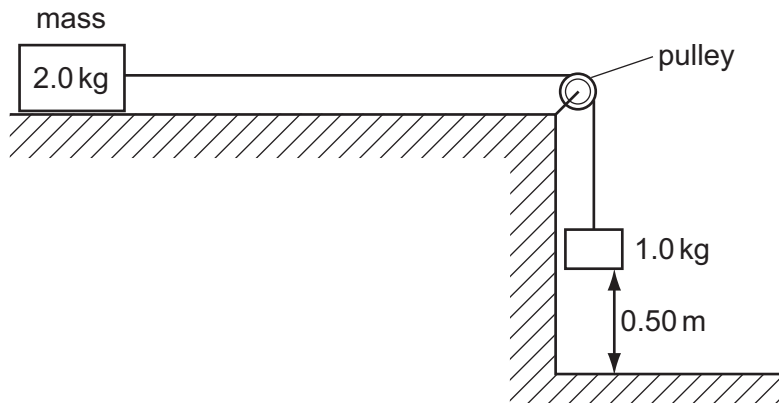

What is the speed of the 2.0 kg mass as the 1.0 kg mass hits the floor, having fallen a distance of 0.50 m?

- A  $1.8 \text{ ms}^{-1}$       B  $2.2 \text{ ms}^{-1}$       C  $3.1 \text{ ms}^{-1}$       D  $9.8 \text{ ms}^{-1}$

Space for working

- 14 A lead pellet is shot vertically upwards into a clay block that is stationary at the moment of impact but is able to rise freely after impact.

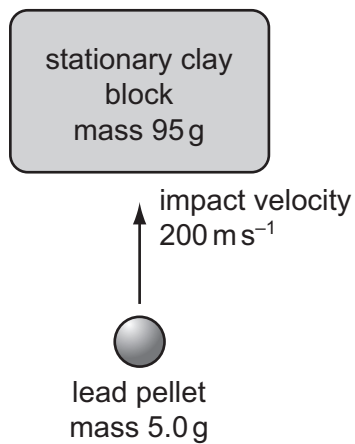

The pellet hits the block with an initial velocity of  $200 \text{ m s}^{-1}$ . It embeds itself in the block and does not emerge.

How high above its initial position will the block rise?  
(Mass of pellet = 5.0 g; mass of clay block = 95 g.)

- A** 5.1 m      **B** 5.6 m      **C** 10 m      **D** 2000 m

**Space for working**

- 15 The diagram shows an experiment to measure the force exerted on a ball by a horizontal air flow.

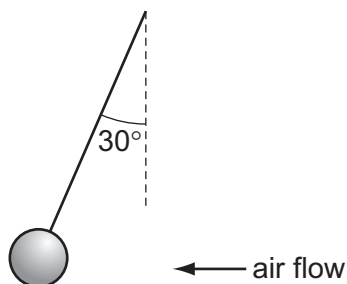

The ball is suspended by a light string and weighs 0.15 N.

The deflection of the string from vertical is  $30^\circ$ .

What is the force on the ball from the air flow?

- A** 0.075 N      **B** 0.087 N      **C** 0.26 N      **D** 0.30 N
- 16 A student balances a 30 cm ruler on a fulcrum set at the 15 cm mark. She then places a 50 g mass on the 23 cm mark and a 20 g mass on the 11 cm mark, as shown.



Which mass should she place on the 7 cm mark to restore the balance?

- A** 30 g      **B** 40 g      **C** 47 g      **D** 133 g

**Space for working**

- 17 A sledge slides down a slope at a constant velocity. The three forces that act on the sledge are the normal contact force  $C$ , the weight  $W$  and a constant frictional force  $F$ .

Which diagram represents these forces acting on the sledge?

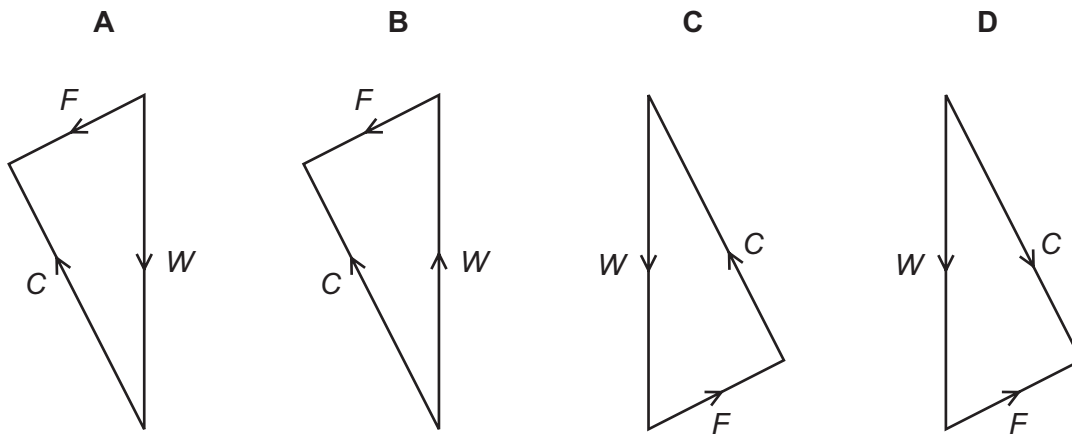

- 18 The kinetic energy of a particle is increased by a factor of 4.

By what factor does its speed increase?

- A 2                      B 4                      C 8                      D 16

- 19 A piston in a gas supply pump has an area of  $600 \text{ cm}^2$  and it moves a distance of 40 cm during one stroke. The pump moves the gas against a fixed pressure of 5000 Pa.

How much work is done by the piston during one stroke?

- A  $1.2 \times 10^2 \text{ J}$       B  $1.2 \times 10^4 \text{ J}$       C  $1.2 \times 10^6 \text{ J}$       D  $1.2 \times 10^8 \text{ J}$

**Space for working**

- 20 A railway engine accelerates a train of total mass 800 tonnes (1 tonne = 1000 kg) from rest to a speed of  $50 \text{ m s}^{-1}$ .

How much work must be done on the train to reach this speed?

- A  $1.0 \times 10^6 \text{ J}$     B  $2.0 \times 10^6 \text{ J}$     C  $1.0 \times 10^9 \text{ J}$     D  $2.0 \times 10^9 \text{ J}$

- 21 Water from a reservoir is fed to the turbine of a hydroelectric system at a rate of  $500 \text{ kg s}^{-1}$ . The reservoir is 300 m above the level of the turbine.

The electrical output from the generator driven by the turbine is 200 A at a potential difference of 6000 V.

What is the efficiency of the system?

- A 8.0%    B 8.2%    C 80%    D 82%

- 22 Which row correctly describes the spacing, ordering and motion of the molecules in water and in ice when both are at a temperature of  $0^\circ \text{C}$ ?

|          | spacing                                                      | ordering                                               | motion                                                      |
|----------|--------------------------------------------------------------|--------------------------------------------------------|-------------------------------------------------------------|
| <b>A</b> | molecules in ice are closer together than molecules in water | a regular pattern of molecules in both ice and water   | molecules in both ice and water have the same average speed |
| <b>B</b> | molecules in ice are closer together than molecules in water | a regular pattern of molecules in ice but not in water | molecules in ice travel more slowly than those in water     |
| <b>C</b> | molecules in ice are further apart than molecules in water   | a regular pattern of molecules in both ice and water   | molecules in ice travel more slowly than those in water     |
| <b>D</b> | molecules in ice are further apart than molecules in water   | a regular pattern of molecules in ice but not in water | molecules in both ice and water have the same average speed |

**Space for working**

23 Three springs are arranged vertically as shown.

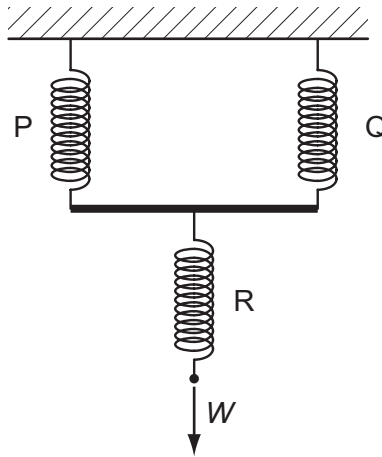

Springs P and Q are identical and have spring constant  $k$ . Spring R has spring constant  $3k$ .

What is the increase in the overall length of the arrangement when a force  $W$  is applied as shown?

A  $\frac{5W}{6k}$

B  $\frac{4W}{3k}$

C  $\frac{7}{2}kW$

D  $4kW$

Space for working



- 24 The diagram shows the stress-strain graph for two wires X and Y of different materials up to their breaking points. Both wires have the same initial dimensions.

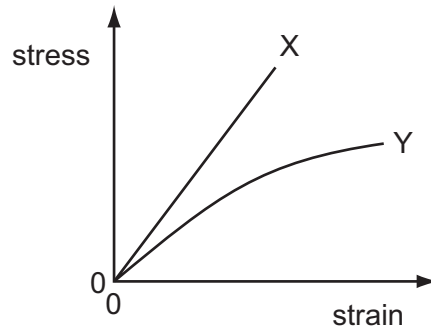

Which statement is **not** correct?

- A Material X extends elastically.  
 B Material X extends more than material Y when loaded with the same force.  
 C Material X has a larger ultimate tensile stress.  
 D Material X is brittle.
- 25 A steel wire and a brass wire are joined end to end and are hung vertically with the steel wire attached to a point on the ceiling. The steel wire is twice as long as the brass wire and has half the diameter.

A large mass is hung from the end of the brass wire so that both wires are stretched elastically.

The Young modulus for steel is  $2.0 \times 10^{11}$  Pa and for brass is  $1.0 \times 10^{11}$  Pa.

What is the ratio of the extension of the steel to the extension of the brass?

- A 2                      B 4                      C 8                      D 16

**Space for working**

26 The diagram shows a graph of displacement against time for a sound wave.

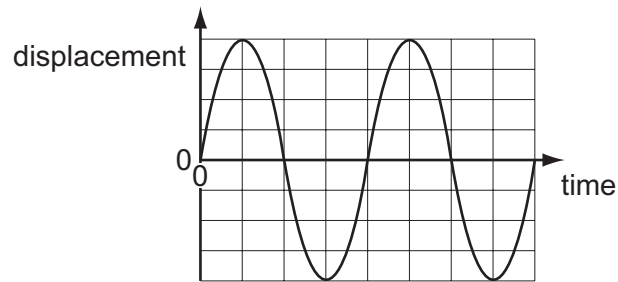

The intensity of the sound is halved.

Which graph shows the displacement of this sound wave?

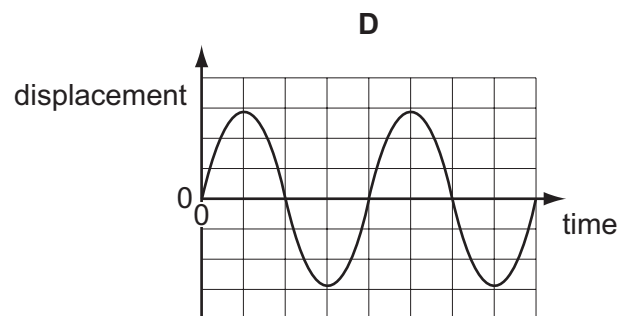
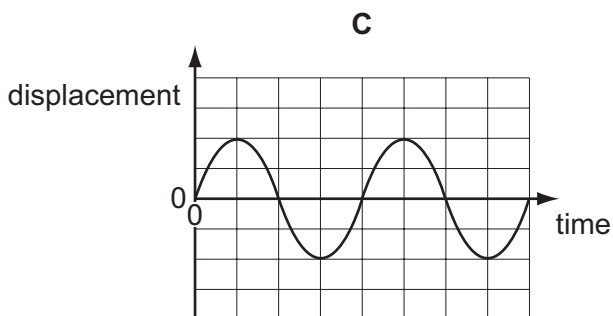
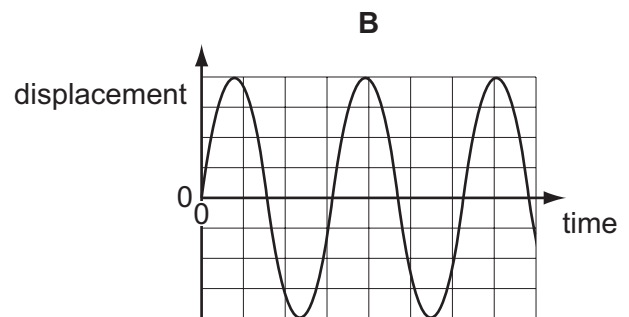
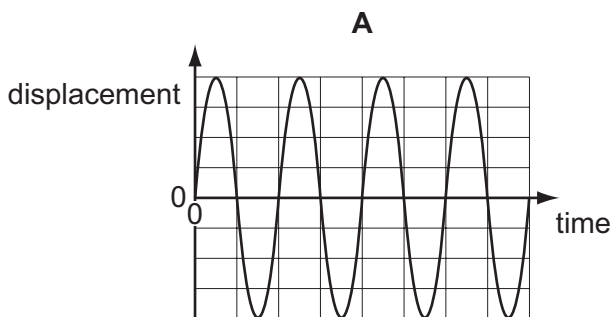

**Space for working**

27 What do **not** travel at the speed of light in a vacuum?

- A electrons
- B microwaves
- C radio waves
- D X-rays

28 A musical organ produces notes by blowing air into a set of pipes that are open at one end and closed at the other.

What is the lowest frequency of sound produced by a pipe of length 10 m?  
(The speed of sound in the pipe is  $320 \text{ m s}^{-1}$ .)

- A 4 Hz
- B 8 Hz
- C 16 Hz
- D 32 Hz

29 Monochromatic light is directed at a diffraction grating as shown.

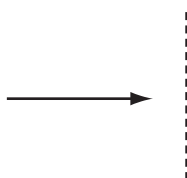

Which diagram shows all the possible directions of the light, after passing through the grating, that give maximum intensity?

A

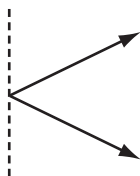

B

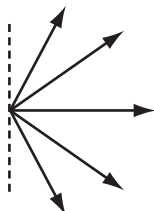

C

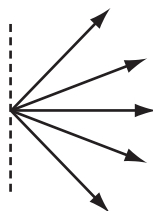

D

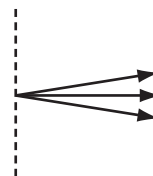

Space for working

30 An electron is initially at rest in a uniform electric field.

Which graph shows the variation with time of the velocity of the electron?

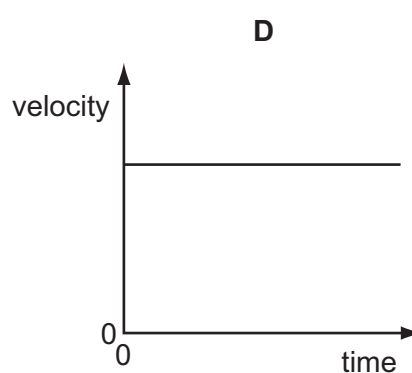
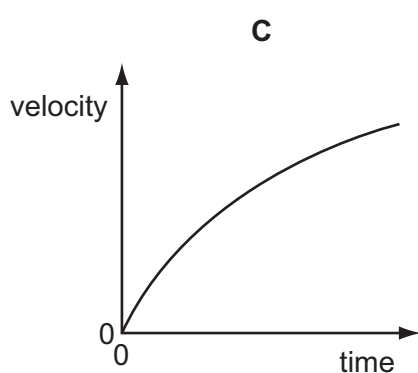
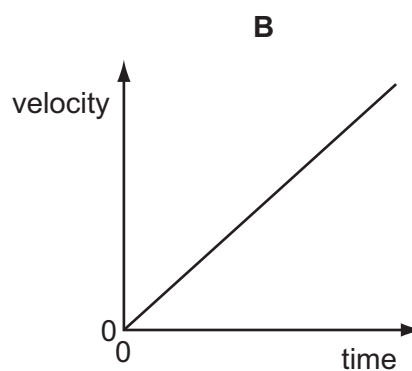
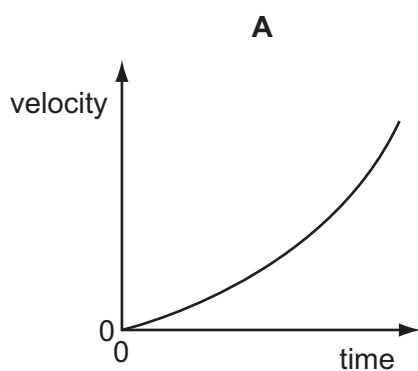

Space for working

- 31 A charged particle is in the electric field between two horizontal metal plates connected to a source of constant potential difference, as shown.

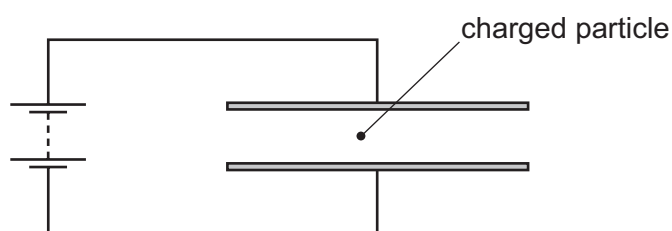

There is a force  $F$  on the particle due to the electric field.

The separation of the plates is doubled.

What will be the new force on the particle?

- A  $\frac{F}{4}$       B  $\frac{F}{2}$       C  $F$       D  $2F$
- 32 The potential difference between point X and point Y in a circuit is 20V. The time taken for charge carriers to move from X to Y is 15 s. In this time, the energy of the charge carriers changes by 12J.

What is the current between X and Y?

- A 0.040 A      B 0.11 A      C 9.0 A      D 25 A

**Space for working**

33 A cylindrical wire of length 10 m and diameter 2.0 mm has a resistance of  $0.050\ \Omega$ .

From which material is the wire made?

|          | material | resistivity/ $\Omega\text{m}$ |
|----------|----------|-------------------------------|
| <b>A</b> | bronze   | $1.6 \times 10^{-7}$          |
| <b>B</b> | nichrome | $1.6 \times 10^{-6}$          |
| <b>C</b> | silver   | $1.6 \times 10^{-8}$          |
| <b>D</b> | zinc     | $6.3 \times 10^{-8}$          |

34 The  $I$ - $V$  characteristics of two electrical components P and Q are shown below.

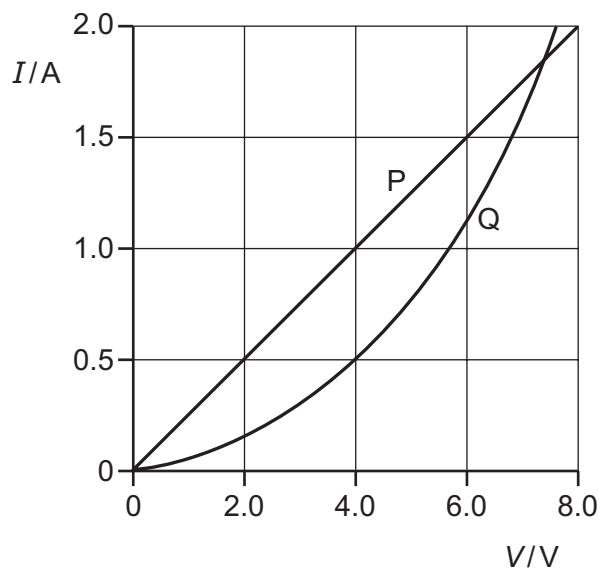

Which statement is correct?

- A** P is a resistor and Q is a filament lamp.
- B** The resistance of Q increases as the current in it increases.
- C** For a current of 1.9 A, the resistance of Q is approximately half that of P.
- D** For a current of 0.5 A, the power dissipated in Q is double that in P.

**Space for working**

- 35 In a fire alarm system, a thermistor T has a resistance of  $2000\Omega$  at room temperature. Its resistance decreases as the temperature increases. The alarm is triggered when the potential difference between X and Y reaches  $4.5\text{V}$ .

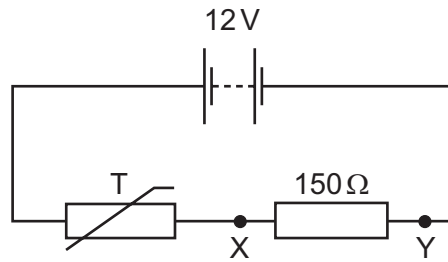

What is the resistance of the thermistor when the alarm is triggered?

- A  $90\Omega$                       B  $150\Omega$                       C  $250\Omega$                       D  $1300\Omega$
- 36 A network of electrical components is connected across a battery of negligible internal resistance, as shown.

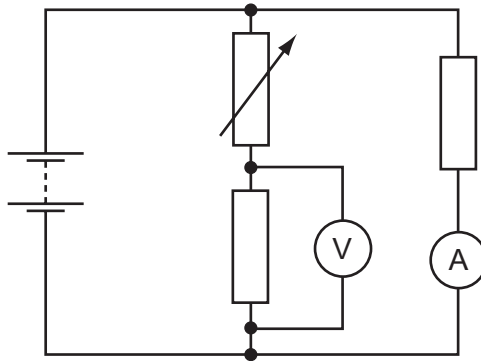

The resistance of the variable resistor is increased.

What is the effect on the readings of the ammeter and voltmeter?

|          | ammeter   | voltmeter |
|----------|-----------|-----------|
| <b>A</b> | decreases | increases |
| <b>B</b> | increases | decreases |
| <b>C</b> | unchanged | decreases |
| <b>D</b> | unchanged | increases |

Space for working

37 The diagram shows a potentiometer circuit.

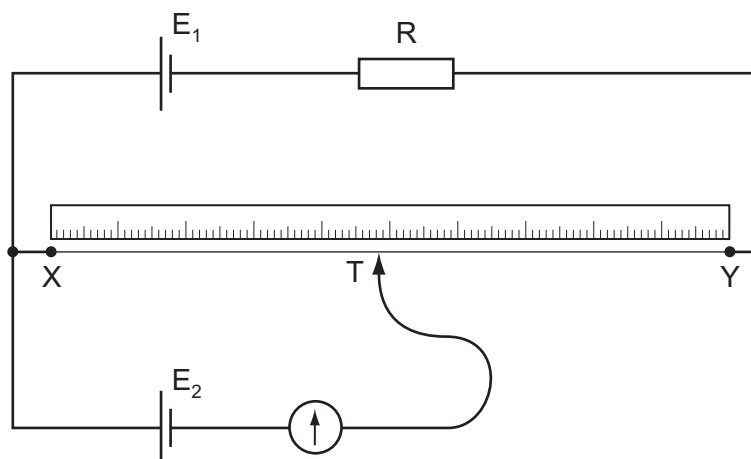

The contact T is placed on the wire and moved along the wire until the galvanometer reading is zero. The length XT is then noted.

In order to calculate the potential difference per unit length of the wire XY, which value must also be known?

- A the e.m.f. of the cell  $E_1$
- B the e.m.f. of the cell  $E_2$
- C the resistance of resistor R
- D the resistance of the wire XY

**Space for working**



- 38 A class of students used dice to simulate radioactive decay. After each throw, those dice showing a '6' were removed. The graph shows the results.

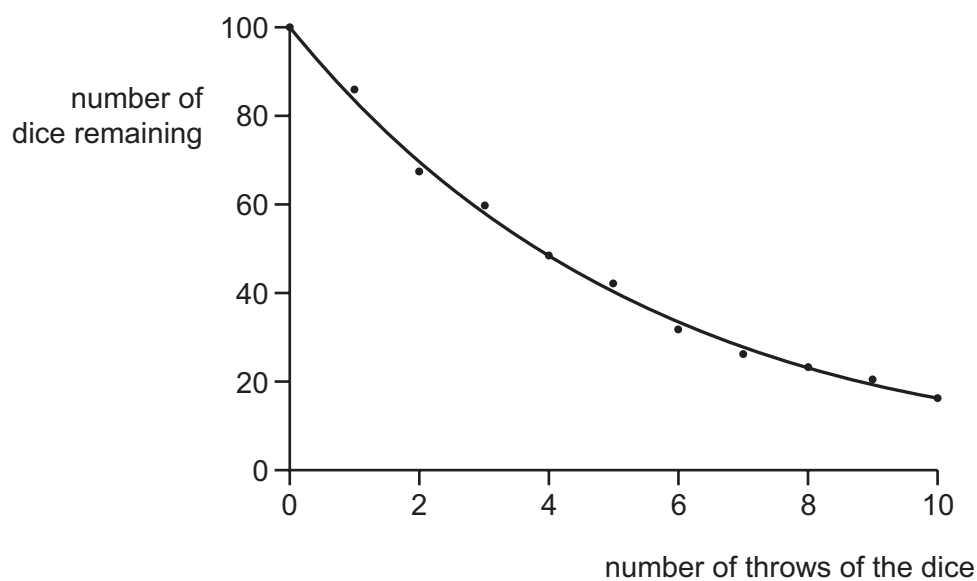

What could the scatter of points about the best-fit curve represent for actual radioactive decay?

- A background count not being taken into account
- B more than one type of radiation being present
- C the random nature of radioactive decay
- D the spontaneous nature of radioactive decay

**Space for working**

39 Which statement about alpha, beta and gamma radiation is correct?

- A Alpha radiation has the greatest ionising power.
- B Beta radiation has the greatest ionising power.
- C Gamma radiation has the greatest ionising power.
- D Alpha, beta and gamma radiation have nearly equal ionising powers.

40 In a radioactive decay series, three successive decays each result in a particle being emitted.

The first decay results in the emission of a  $\beta$ -particle. The second decay results in the emission of an  $\alpha$ -particle. The third decay results in the emission of another  $\beta$ -particle.

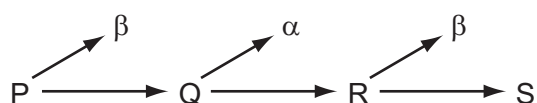

Nuclides P and S are compared.

Which statement is correct?

- A P and S are identical in all respects.
- B P and S are isotopes of the same element.
- C S is a different element of lower atomic number.
- D S is a different element of reduced mass.

**Space for working**



**BLANK PAGE**

---

Permission to reproduce items where third-party owned material protected by copyright is included has been sought and cleared where possible. Every reasonable effort has been made by the publisher (UCLES) to trace copyright holders, but if any items requiring clearance have unwittingly been included, the publisher will be pleased to make amends at the earliest possible opportunity.

University of Cambridge International Examinations is part of the Cambridge Assessment Group. Cambridge Assessment is the brand name of University of Cambridge Local Examinations Syndicate (UCLES), which is itself a department of the University of Cambridge.